



WATERPLAY

BY **MAKER**



**ACTIVITY TOWER
INSTALLATION
MANUAL**

Contact Information

For additional information please contact Waterplay® Solutions Corp. (Waterplay):

MAILING ADDRESS

805 Crowley Avenue

Kelowna, BC Canada

VIY 7G6

TELEPHONE (Mon – Fri 7:00 a.m. to 5 p.m. Pacific Time)

1-800-590-5552 in North America

01-250-712-3393 International

EMAIL

parts@waterplay.com

ONLINE

www.waterplay.com



TABLE OF CONTENTS

1.0	Site / Installation Preparation.....	4
1.1	Call Before You Dig.....	4
1.2	Site Conditions.....	4
1.3	Waterplay Kickoff Meeting.....	4
1.4	General Assembly Considerations.....	4
1.5	Tips & Tricks.....	5
2.0	Slab & Footing.....	6
2.1	Play Pod Hex.....	7
2.2	Play Pod Octo.....	7
3.0	Column Install.....	9
3.1	Main Column Install.....	9
3.1.1	Pod-to-Pod Jig.....	11
3.2	Support Post Install.....	12
3.3	Finishing Touches.....	14
4.0	Deck Installation.....	15
4.1	Play Pod Hex.....	15
4.2	Play Pod Octo.....	16
5.0	Stair & Bridge Installation.....	18
5.1	Entry Stairs.....	18
5.2	Transition Stairs.....	20
5.3	Bridge.....	20



6.0	Railing Panel Installation.....	21
7.0	Flume Installation.....	22
8.0	Feature Installation	24
8.1	Main Column Feature.....	24
8.2	Floating / Supporting Column Features	24
9.0	Water Distribution	26
9.1	Main Water Inlet(s).....	26
9.2	Column Features	27
9.2.1	Play Pod Hex.....	27
9.2.2	Play Pod Octo.....	28
9.3	Panel Features	28
9.3.1	Play Pod Hex.....	28
9.3.2	Play Pod Octo.....	29
9.4	Central Features.....	30
9.5	Low Point Drainage / Winterization.....	30
10.0	Safety Netting / Panel Installation.....	31
10.1	Safety Netting.....	31
10.1.1	Play Pod Hex.....	31
10.1.2	Play Pod Octo.....	32
10.2	Safety Panels	33
10.2.1	Play Pod Hex.....	33
10.2.2	Play Pod Octo.....	34



1.0 SITE / INSTALLATION PREPARATION

1.1 Call Before You Dig

As with any Waterplay park, contact local “Call Before You Dig” groups to obtain proper approvals and information before beginning site work.

1.2 Site Conditions

A level concrete slab is ideal for installation of the Activity Tower; any other type of installation must first be deemed possible by Waterplay during planning stages. Be aware of and comply with local codes that may apply to minimum distances around structure, drainage, etc. In some instances, a fall attenuating surface may be required by local codes depending on the height of the structure.

1.3 Waterplay Kickoff Meeting

Gather all information about slide and park features, and ensure documents are reviewed by all parties. Before any construction happens, be sure that all required permits and approvals are in place, and a proper project installation schedule has been completed.

Waterplay recommends a project kick-off meeting with a Waterplay Technical Support Representative to discuss the project.

1.4 General Assembly Considerations

Waterplay recommends assembling the structure in the following order:

1. Stub up central column supply piping
2. Central Column(s) (anchor adhesive and grounding lugs not provided by Waterplay)
3. Decking
4. Support Columns / Floating Columns (anchor adhesive and grounding lugs not provided by Waterplay)
5. Stairs / Bridge(s)
6. Railing Panels



7. Flume(s)
8. Features
9. Plumbing (Feature piping, fittings, and valves provided by Waterplay. Pipe to be cut to length on site)
10. Safety Netting / Panels

1.5 Tips & Tricks

- ◆ Review this manual, the Operation and Installation Manual, feature specs, feature installation drawings, site layout drawings, and mechanical workbook in full before beginning assembly.
- ◆ Check inventory and sort hardware upon receipt.
- ◆ For multi-pod structures, check spacing of supply stub ups prior to starting assembly.
- ◆ Ensure first central column is set at the correct orientation. For multi-pod structures, use provided jig to orient columns with respect to one another.
- ◆ Set first central column to match high point elevation on the slab. This will allow you to grout up to all other structure contact points on the slab rather than grinding down.
- ◆ Pressure test central column(s) before further assembly to ensure a proper seal between the supply line(s) and the tapered urethane seal(s).
- ◆ Loosely thread hardware until structure has been assembled to allow for easier alignment of parts.
- ◆ Apply anti-seize to all stainless-steel fasteners.
- ◆ Keep protective film on panels until assembly is complete to reduce risk of damage to acrylic surfaces.
- ◆ Avoid walking on deck anti-slip decals with dirty footwear. Place a protective surface on decking during construction/assembly.
- ◆ Avoid over tightening acrylic panels as this can cause cracking.
- ◆ Support exposed plumbing using standoff brackets (by others).
- ◆ Flush all lines prior to installing performance nozzles to remove any loose debris.
- ◆ Wait to install netting/lower panels until feature flows have been adjusted.
- ◆ Use zip ties to temporarily secure netting while installing with provided kayak cord.



NOTE

Ensure anti-seize is applied to all stainless-steel fasteners in order to prevent galling. Loosely fasten hardware during assembly – avoid tightening all hardware until the entire structure has been assembled.

2.0 SLAB & FOOTING

The type of foundation will vary depending on the type of structure and must be approved by a local engineer. For structures made up of multiple pods, follow the details below as they pertain to each pod.

Waterplay recommends a level slab for ease of installation. If the activity tower is being installed on a sloped surface such as a beach entry pool, consider all structure contact points. Grouting beneath baseplates and/or grinding/coring of the pad may be required to accommodate varying elevations.



Figure 1: Grouting Beneath Baseplates



Figure 2: Baseplate with Pad Leveling

2.1 Play Pod Hex

The Play Pod Hex is supported by a single main column, resting on a single engineered footing – see drawing 0010-2410 (Hexadeck Footing) for recommended footing details.

Slab elevation beneath the structure should be considered for all structure contact points – these may include column(s), slide flume(s), stairs, and netting/panels. All structure contact points require a flat thickened slab (see details in Play Pod Octo)

2.2 Play Pod Octo

The Play Pod Octo requires an approved flat thickened slab beneath the whole structure. If the structure is being installed on a sloped pad, please contact Waterplay to discuss the installation. Please consider the following as part of an approved slab:

- ◆ The baseplate of each column will be chemically anchored directly on the final slab – this is done best on a flat concrete slab.
- ◆ The slab must be approved by an engineer to meet applicable local codes and design standards.
- ◆ Minimum recommended reinforcement is #4 (12M) rebar @ 12" (300mm) each direction.



- ◆ Concrete compressive strength: 3000psi (20MPa) at 28 days (minimum).
- ◆ Waterplay Solutions Corp. accepts no responsibility for slab design or installation.



3.0 COLUMN INSTALL

The recommended installation methods for securing a Waterplay Activity Tower are outlined below.

Waterplay recommends pressure testing the main column(s) prior to assembling the rest of the structure in order to ensure a proper seal between the supply line(s) and the tapered urethane seal(s).

3.1 Main Column Install

1. Position the plywood template (supplied by Waterplay) over the water inlet (centered on the footing).
2. Use the template to locate and drill 10" (min) deep holes to accept ¾" A304 SS threaded rod (6 x threaded rod required for Play Pod Hex main column, and 8 x rod for Play Pod Octo main column) – threaded rod provided by Waterplay. Keep in mind the location of the supply line and other site services beneath the slab when drilling holes.
3. Set the anchors with Hilti HY-200 Epoxy, or an equivalent adhesive (adhesive by others).
4. Remove the plywood template, place levelling nuts, washers, and main column flange plate on anchor studs – level flange plate. Note that a plumb column is critical, especially for structures made up of multiple pods where centre to centre spacing of main columns between adjacent pods is crucial. Please refer to Waterplay drawings for project specific pod spacing.
5. It may be necessary to grind the pad in some areas to ensure the flange plate sits at the desired elevation. When setting the elevation, keep in mind other contact points of the structure on the pad.
6. Install the main column flange plate over the threaded rod and leveling nuts/washers followed by the urethane taper seal over the supply pipe, ensuring all surfaces are clean of any debris (see Water Distribution for additional water distribution details).
7. Align main column and install on anchor studs. Secure in place using washers and nuts. Continue to ensure column is plumb as hardware is fully tightened.





Figure 3: A Lift may be Required

Activity tower columns can be heavy and may require the use of a lift or boom. Only qualified operators should operate heavy equipment.

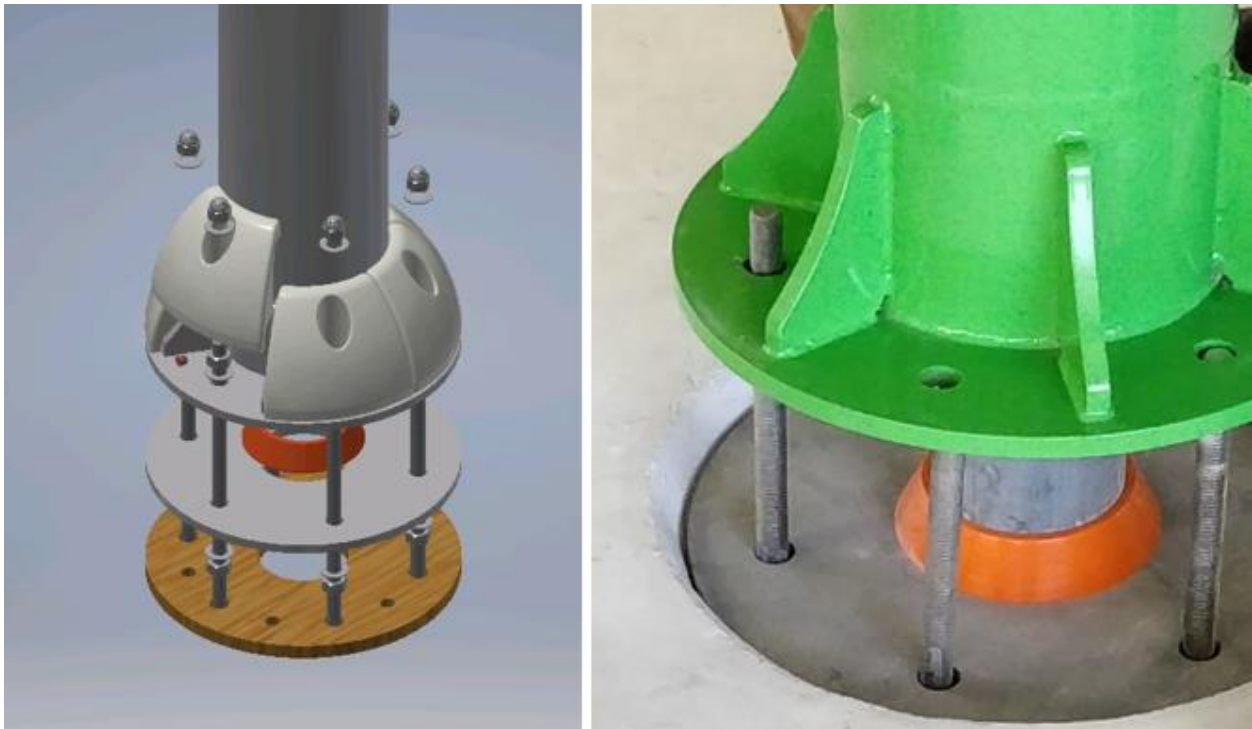

Figure 4: Main Column Over Supply Line Stub

CAUTION

Supply line stub must be 4" (4.5" OD) PVC to ensure proper fit with urethane seal. Alternate urethane seal available upon request to accommodate metric 110mm PVC supply.

3.1.1 Pod-to-Pod Jig

For multi-pod structures, Waterplay provides jigs to set spacing and orientation between main columns. Use the jig(s) to confirm supply line stub up spacing and set your column orientations prior to drilling anchor bolts. Remove and discard jig(s) after setting anchor bolts. Note that different jigs are required depending on neighboring pods including: Hex Pod to Hex Pod, Octo Pod to Hex Pod, and Octo Pod to Octo Pod as shown below from top to bottom, respectively.

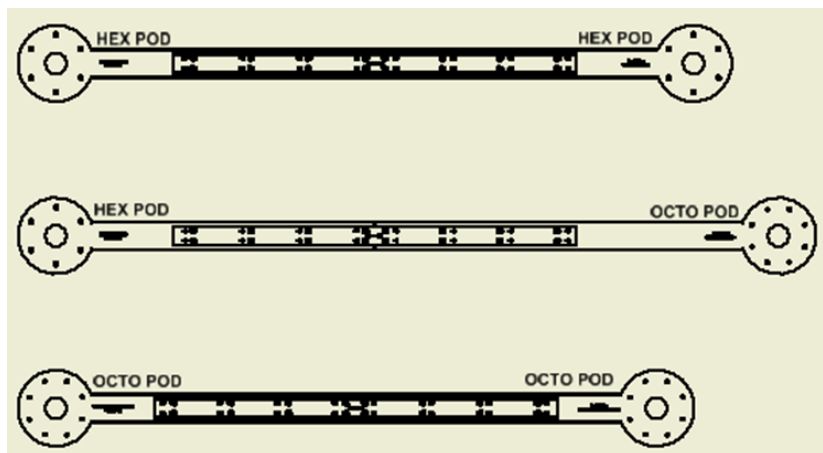

Figure 5: Pod-to-Pod Jigs, Top View



3.2 Support Post Install

In addition to a main column, each Play Pod Octo is supported by eight columns placed evenly around each structure. Each column should be erected as adjacent decking is installed. The pad should be at the same elevation beneath each column in order to ensure a level installation of the structure. In order to account for an uneven pad, Waterplay recommends using plastic packers/shims (supplied by others) varying in thickness - these packers/shims aid in setting columns at appropriate elevations during assembly.

1. Use the provided jig to set spacing and orientation of Play Pod Octo support columns with respect to the pod main column.

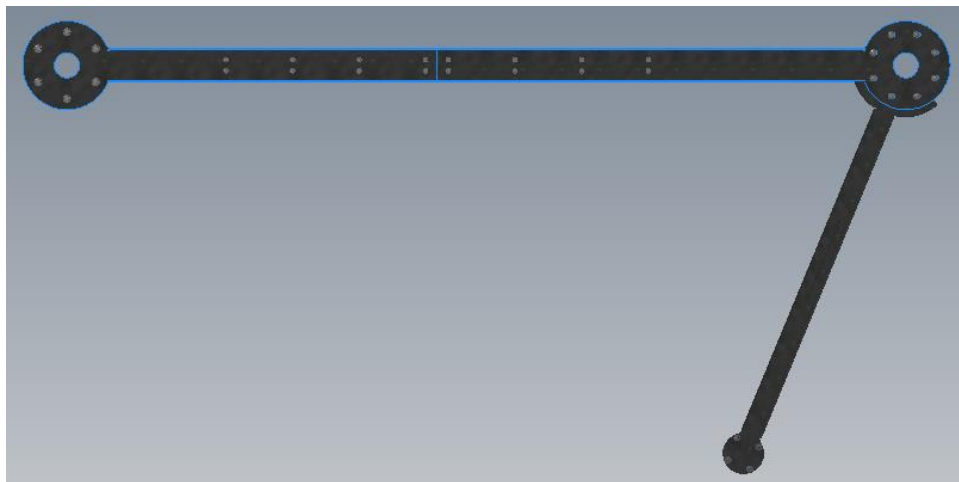

Figure 6: Hex Pod to Octo Pod Jig

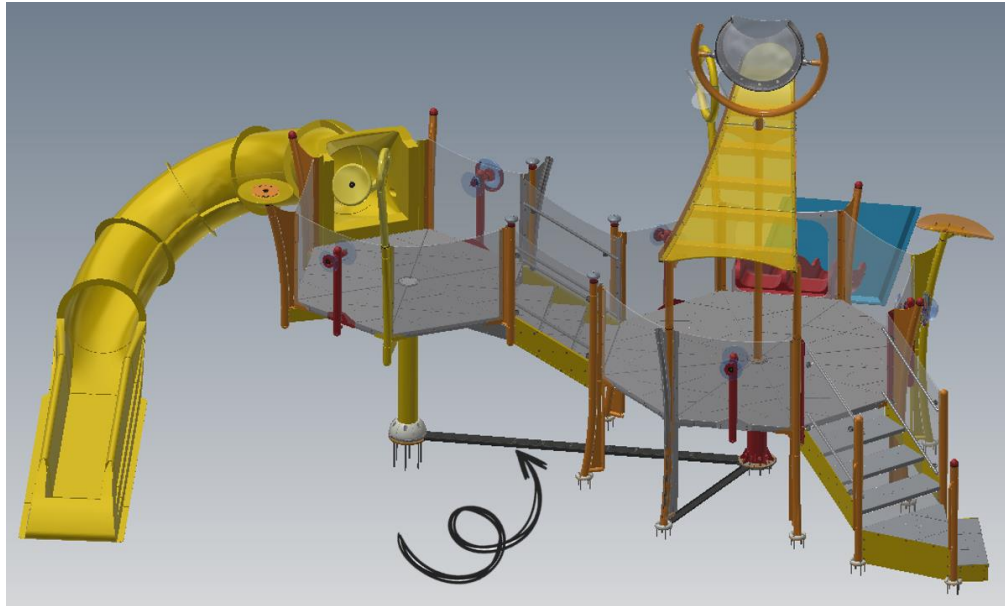

Figure 7: Hex Pod to Octo Pod Jig

2. Drill 4 x 10" (min) deep holes to accept ½" A304 SS threaded rod (provided by Waterplay) for each column.
3. Remove and discard jig after drilling for anchor bolts.
4. Set the anchors with Hilti HY-200 Epoxy, or an equivalent adhesive (adhesive by others).
5. Place leveling nuts and washers on anchor studs.
6. Erect columns as adjacent decking is assembled.
7. Place column on anchors, followed by flange cover, and secure in place using acorn nuts.





Figure 8: Support Post Install

3.3 Finishing Touches

All columns are to be bonded and grounded. Secure a grounding lug to each column (grounding lugs by others). Consult local codes for project specific bonding and grounding requirements.

Once the structure is fully assembled, fill any voids below the column base plates with non-shrink grout. Ensure rounded edges on grout to avoid tripping hazard.

Install flange covers. Cut the anchor bolts to appropriate length and fasten flange covers using acorn nuts.



Figure 9: Installed Main & Support Columns

4.0 DECK INSTALLATION

The best practice for installation of Waterplay Activity Towers is to install the main columns first. If the structure is made up of multiple pods, Waterplay recommends starting with a central pod at a high point on the pad. Next, loosely fasten available deck sections and build out. Apply anti-seize to all stainless-steel hardware. Avoid tightening hardware until the whole structure has been assembled. Once assembled, check that columns are plumb, and decks are level.

4.1 Play Pod Hex

1. Align support arm holes with main column holes. Fasten using $\frac{3}{4}$ " washers and bolts at the main column body. Fasten using a $\frac{3}{4}$ " bolt, washer, and nut at the main column deck mounting flange.
2. Install floating column on each support arm. Fasten to the top of the arm using a $\frac{3}{4}$ " bolt, washer, and nut. Fasten to the post mounting block of the arm using $\frac{3}{4}$ " bolts and washers.

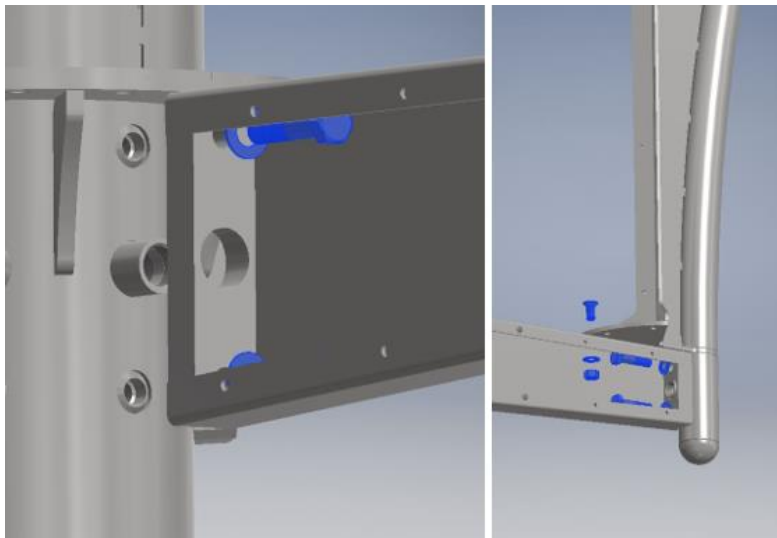

Figure 10: Deck Support Assembly



- Place decks on top of two adjacent support arms. Fasten to main column deck mounting flange using $\frac{1}{2}$ " bolts, washers, and nuts. Fasten to floating column deck mounting plate using $\frac{1}{2}$ " bolts, washers, and nuts. Secure adjacent decks to one another using $\frac{1}{2}$ " bolts, washers, and nuts.

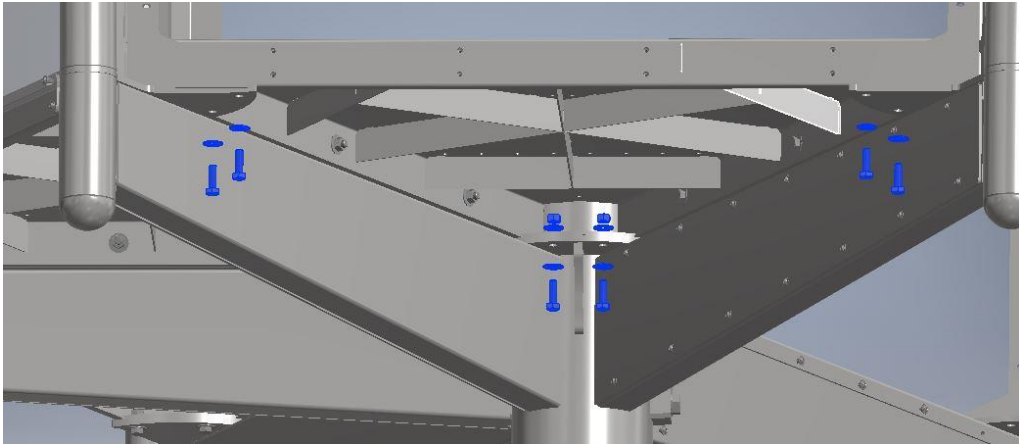

Figure 11: Deck Assembly

4.2 Play Pod Octo

- Align deck holes with appropriate main column deck mounting flange holes. Fasten using $\frac{1}{2}$ " bolts, washers, and nuts.

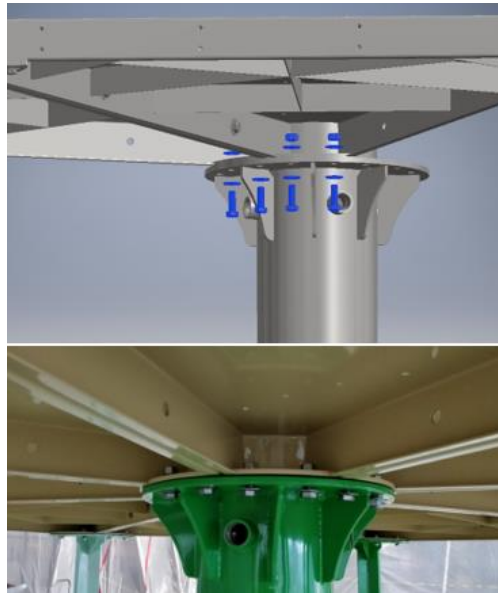

Figure 12: Deck Assembly on Main Column



- Secure adjacent decks to one another using $\frac{1}{2}$ " bolts, washers, and nuts.

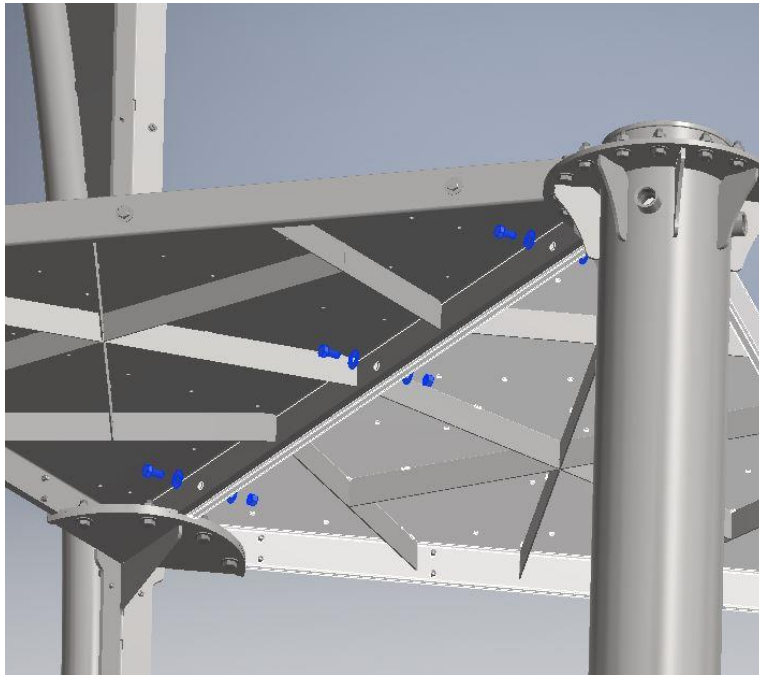

Figure 13: Adjacent Deck Assembly

- Erect support columns and fasten to each deck using $\frac{1}{2}$ " bolts, washers, and nuts.

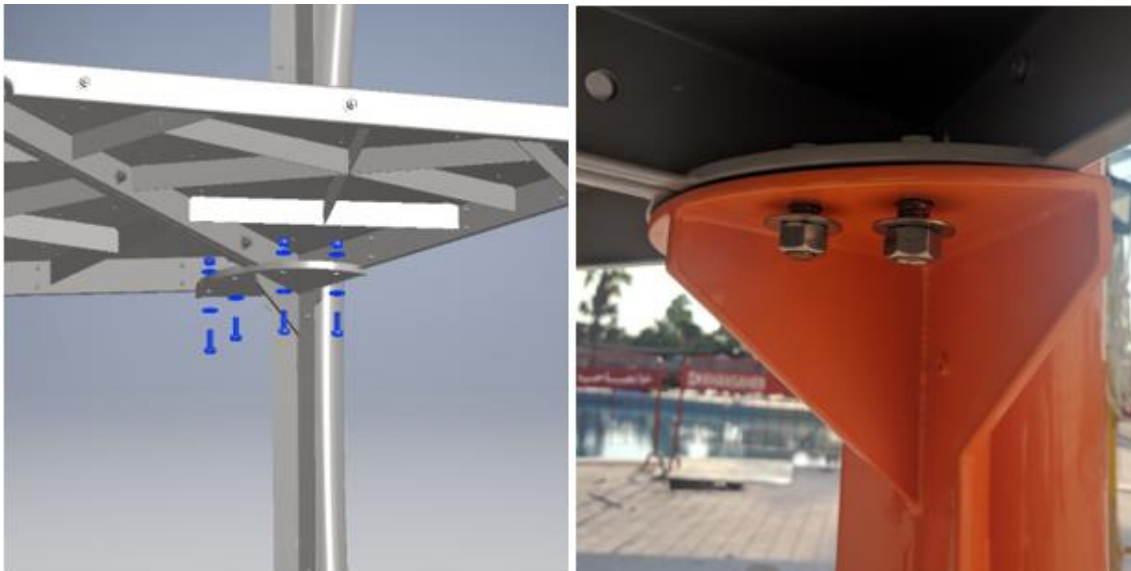

Figure 14: Support Column Assembly

5.0 STAIR & BRIDGE INSTALLATION

The quantity and type of stairs may vary depending on the heights of the pod(s), and the number of pods. Please refer to project specific stair installation details (provided upon order).

5.1 Entry Stairs

Entry stairs refer to stairs which provide access to the pod deck from the main slab. Entry stairs come in different styles with platforms to conform to local requirements – please refer to project specific stair installation details.

1. The pad elevation at the base of, and leading up to the stairs is critical in order to ensure the rise to the first step is consistent with all other stair risers. If necessary, grout up to the base of the stairs in order to minimize any discrepancies in the rise of the first step.
2. Fasten the left and right stair mounting brackets to the pod floating / support columns using $\frac{1}{4}$ " bolts, washers, and nuts.

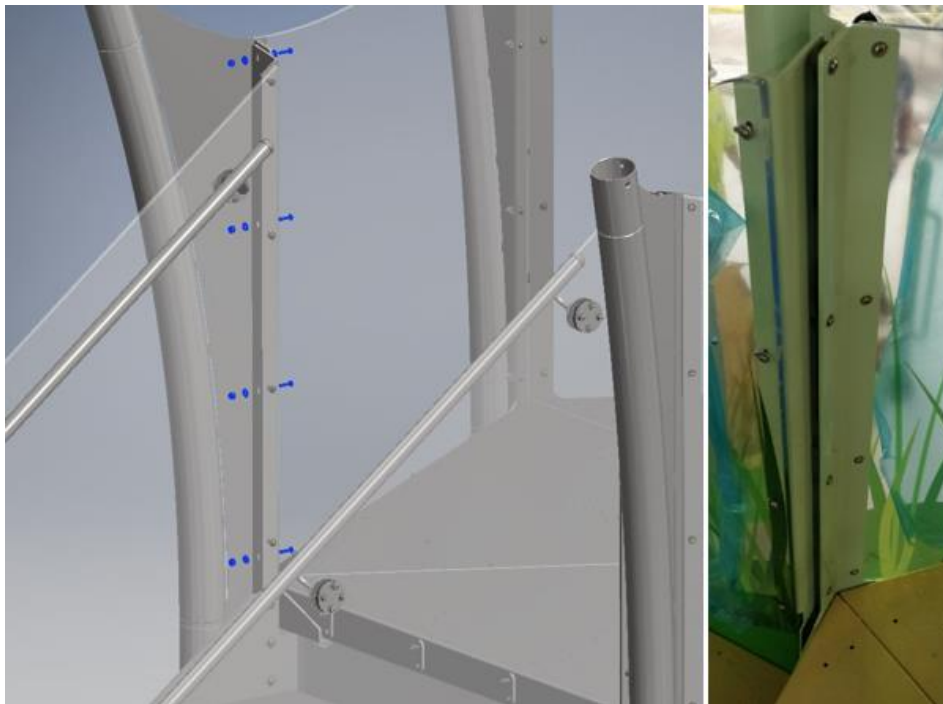

Figure 15: Entry Stair Assembly



3. Columns at the base of the stairs are to be chemically anchored similar to structure support columns.



Figure 16: Stair Column Assembly

5.2 Transition Stairs

Transition stairs refer to stairs which provide access between adjacent pods of different elevations.

1. Loosely fasten upper and lower right-hand and left-hand mounting brackets to pod floating / support columns using $\frac{1}{4}$ " bolts, washers, and nuts. Avoid tightening hardware until the whole structure has been assembled.



Figure 17: Transition Stairs Assembly

5.3 Bridge

A bridge provides access to adjoining pods of the same elevation.

Similar to transition stairs, loosely fasten left-hand and right-hand mounting brackets to pod floating / support columns using $\frac{1}{4}$ " bolts, washers, and nuts. Avoid tightening hardware until the whole structure has been assembled.



6.0 RAILING PANEL INSTALLATION

Waterplay panels are constructed of a clear acrylic material. Panels are installed on the outside of the structure decking, and fastened in place via the provided hardware. Do not overtighten hardware to avoid cracking panels.

2. Install panels between floating / support columns.
3. Fasten panels to columns using ¼" bolts, washers, and nuts.
4. Fasten to decks using railing panel spacers and ¼" bolts and washers.



Figure 18: Panel Installation

7.0 FLUME INSTALLATION

Flume installation will vary depending on projects; various styles are available depending on the slide model ordered. Consult project specific flume installation drawing(s) for project specific details. Note that supplementary materials such as Sikaflex as well as pipe and fittings may be required to complete the flume installation.

Note that flume drainage should be planned for. A sump pit may be required to collect water and drain appropriately – consult project specific flume installation detail for manufacture requirements.

Flumes are plumbed separately from the main column, and require dedicated supplies stubbed up beneath the structure. Please consult project specific mechanical workbook to determine which flumes require plumbing connections.



Figure 19: Flume Installation & Plumbing





Figure 20: Flume Run Out

Inspect all flume joints to ensure smooth transitions between all flume sections.

Once construction is complete, ensure all construction debris is cleaned from the slide flume(s). Waxing of the flume(s) may be necessary as well in order to ensure the surface is appropriate for use. See Waterplay Operations and Installation Manual and Fiberglass Slide Maintenance and Repair Manual for recommended ongoing maintenance.



Figure 21: Installed Slide

8.0 FEATURE INSTALLATION

Activity Tower features will vary; project specific installation drawings will be provided in the project binder.

8.1 Main Column Feature

Central features are to be installed directly over the main column via Waterplay's playPHASE mounting system.

1. Remove the playPHASE blank plate.
2. Ensure all flange faces are clean and the gasket is properly seated.
3. Install the feature and secure using ½" bolts.

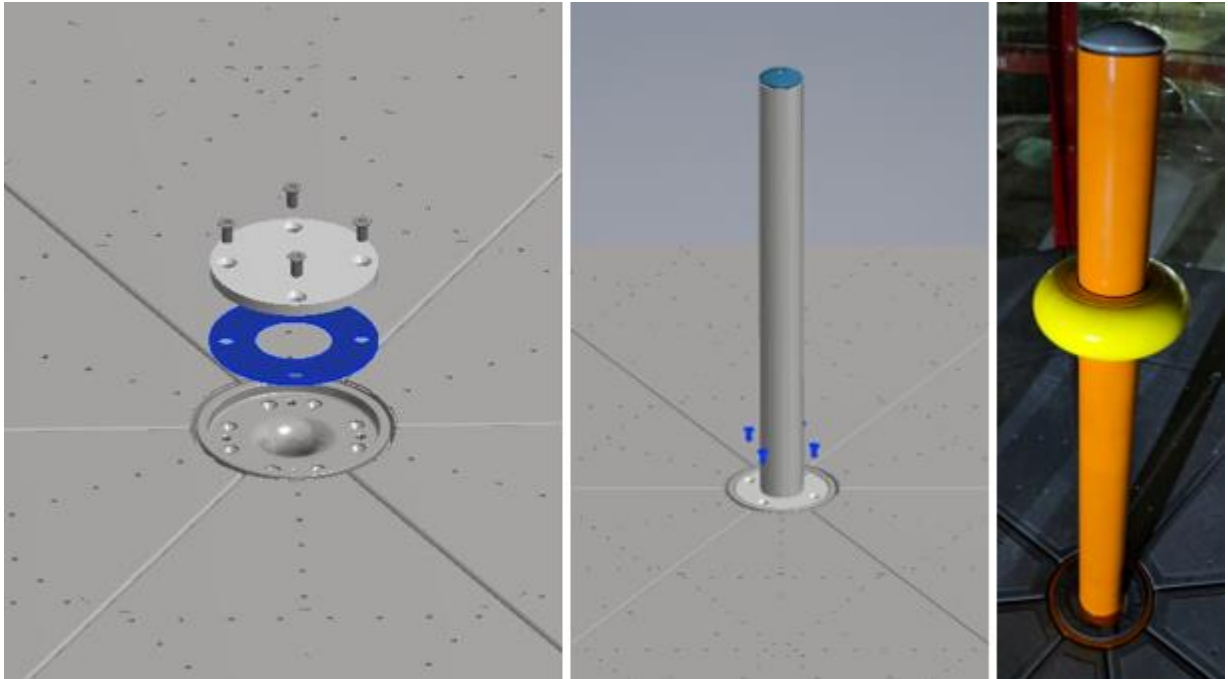

Figure 22: Fun-Brella Installation

8.2 Floating / Supporting Column Features

All outside column features are installed via Waterplay's playCONNECT mounting system.



1. Consult project specific structure specification to determine feature placements on the structure.
2. Feature assembly can vary – consult feature specific install details.
3. For features with rotational hubs, ensure hub is oriented correctly so that the feature sprays away from the structure.
4. Place the feature on the feature column and secure using ¼" bolts.

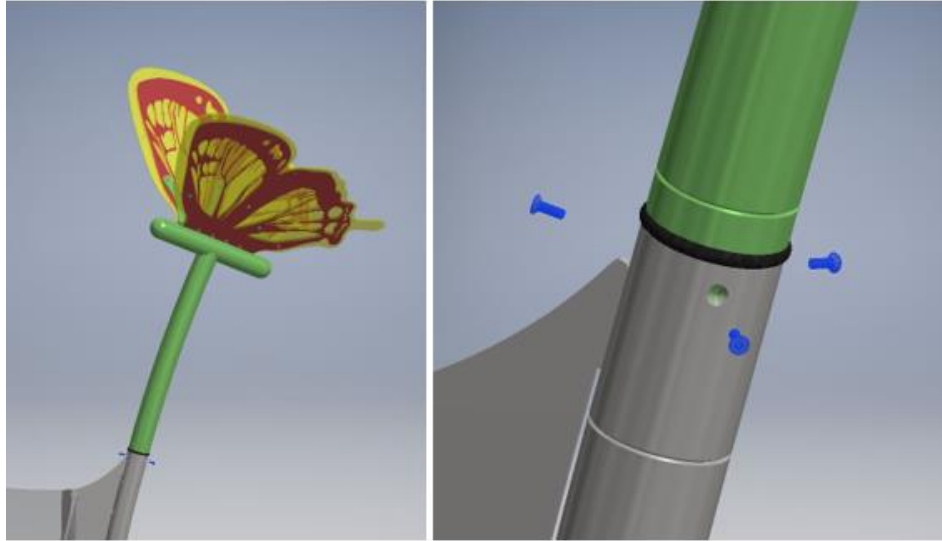

Figure 23: Flutter Installation

5. Some features require additional support legs which are to be chemically anchored to the slab similar to all other support columns using threaded rod, levelling nuts, flange cover and acorn nuts.

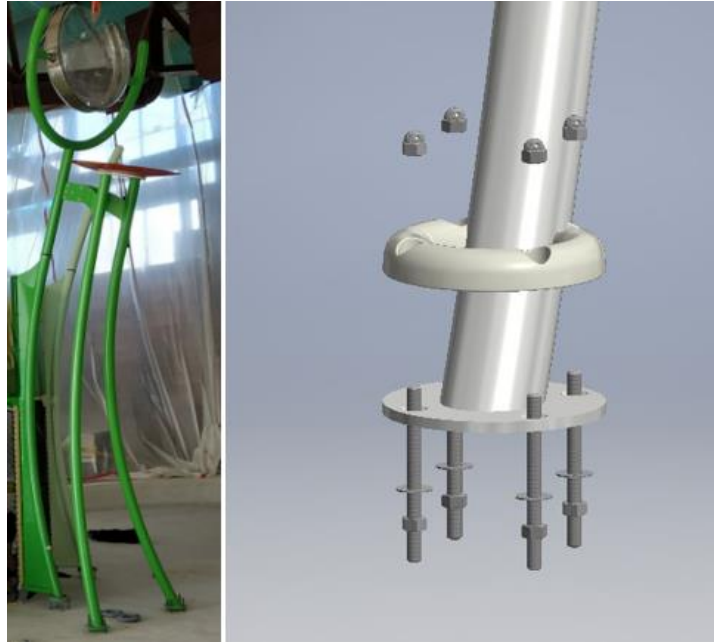

Figure 24: Lady Bug Soaker Support Leg Installation

9.0 WATER DISTRIBUTION

Plumbing connections can vary depending on the type, and number of pods. Please refer to the project specific structure specification and mechanical workbook to determine the number of features which require plumbing connections. Note that Waterplay provides a roll(s) of flexible PVC pipe which is to be cut to length on site. Fittings and flow control valves are also provided by Waterplay and much be installed on site.

Typically, piping is connected from the main column to feature columns – the exception to this guideline being slide flumes (see Flume Installation). For ease of installation, Waterplay provides flexible PVC piping for all above ground plumbing connections (excluding slide flumes).

9.1 Main Water Inlet(s)

Each Activity Tower main column requires a 4" (4.5" outside diameter) PVC supply stub up (*Alternate urethane seal available upon request to accommodate a metric 110mm PVC supply). This stub up feeds water to the main column, which in turn feeds the features for that specific pod. Structures which are made up of multiple pods will require a 4" stub up for each pod (by others).



Pump (if applicable) and supply line sizing prior to the 4" stub up are to be provided by others and will vary depending on the structure maximum flow rate. Please consult the project mechanical workbook for project specific structure flowrate.

9.2 Column Features

9.2.1 Play Pod Hex

1. Connect piping to the main column 1" NPT female couplers, ball valves, and feature column 1" NPT female couplers.
2. Piping is to be run inside the support arms.
3. Once the Activity Tower installation is complete and final flow adjustments have been made using the provided ball valves, secure the support arm cover plates using 1/4" washers and bolts.



Figure 25: Floating Column Water Distribution

9.2.2 Play Pod Octo

Connect piping to the main column bottom 1" NPT female couplers, ball valves, and feature column 1" NPT female couplers.

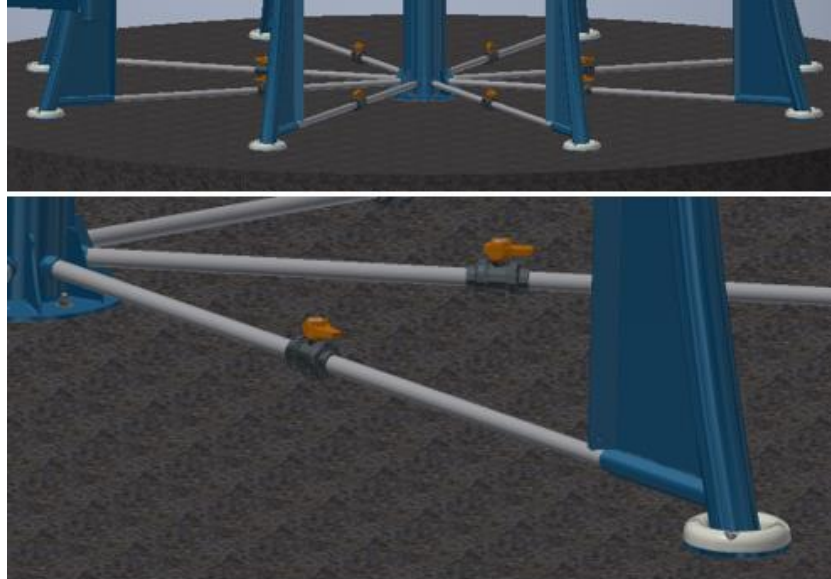

Figure 26: Piping to Support Columns

9.3 Panel Features

9.3.1 Play Pod Hex

1. Tee off support column piping at the access hole in the support arm cover plate.
2. Install ball valve to control flow to Panel Activities independently from floating column features.
3. Ensure ball valve for floating column is installed downstream of the tee connection.





Figure 27: Tee Line to Connect to Panel Feature

9.3.2 Play Pod Octo

Connect piping to the main column upper 1" NPT female couplers, ball valves, and Panel Activity 1" NPT female couplers.

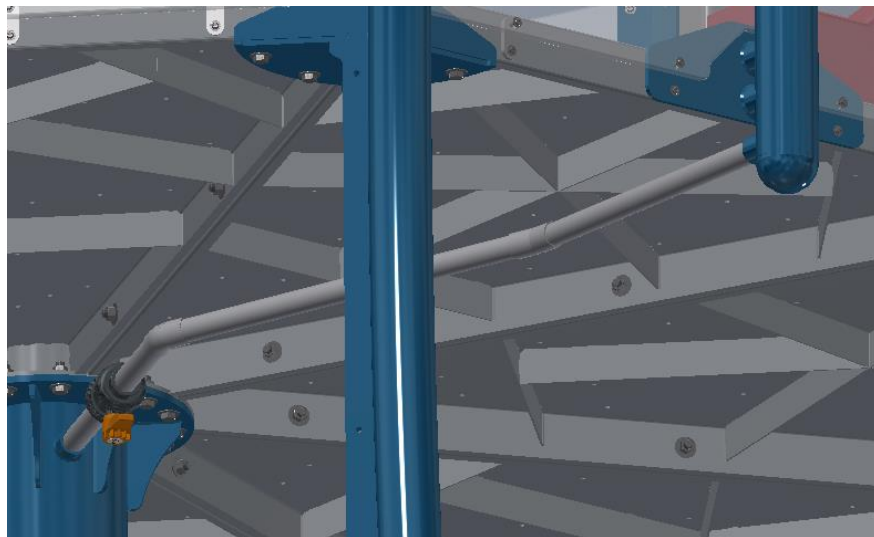

Figure 28: Panel Feature Piping from Main Column

Any unused central column upper ports must be plugged.



Figure 29: Plugged Upper Ports

9.4 Central Features

An optional central feature can be installed on each pod. This feature is fed directly from the pod main column via a standard playPHASE mounting system.

9.5 Low Point Drainage / Winterization

A low point drainage area should be planned for within the piping system for winterization and system maintenance. This would include a drainage pit capable of handling a large amount of water when the park drains, as well as appropriate piping sloped away from the site. The low point drainage pit should be located at the lowest point of the piping system to allow water to gravity drain away from the Aquatic Play Pad.

Additionally, each central column includes a ¼" drain plug located at the base of the column. This is to be removed to allow for appropriate drainage of the structure.

As an extra precaution, Waterplay recommend introducing RV antifreeze into the lines for winterization.



10.0 SAFETY NETTING / PANEL INSTALLATION

The safety netting / panels fit around the bottom of pods, stairs, and bridges to keep children from accessing areas underneath of the structure. Ensure a level surface for netting/panel contact points on the slab.

10.1 Safety Netting

Safety netting is available in 52" lengths for decks, stairs, and bridges less than 8' in height. The netting for Activity Towers is designed to last 2 seasons, after which time replacement netting can be purchased through Waterplay.

10.1.1 Play Pod Hex

1. Fasten brackets to the deck using $\frac{1}{4}$ " bolts and washers.
2. Fasten brackets to the slab using $\frac{1}{4}$ " anchors, screws, and washers.
3. Secure netting to brackets using kayak cord.
4. Secure sections of netting to each other using kayak cord.

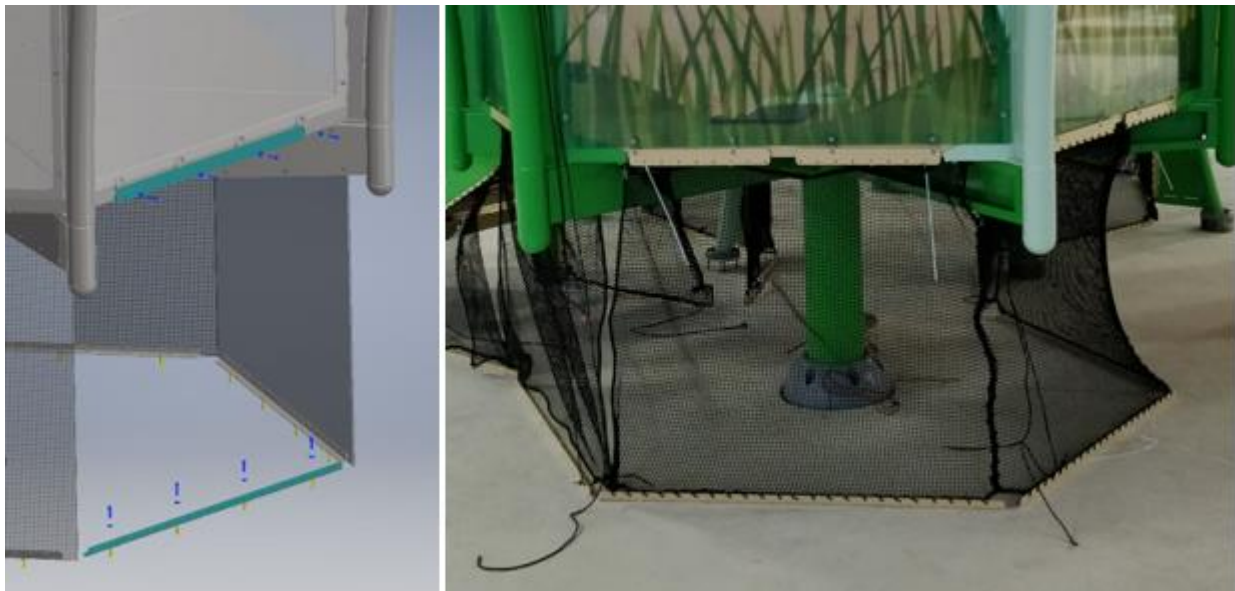

Figure 30: Play Pod Hex Netting Installation

10.1.2 Play Pod Octo

1. Fasten brackets to the deck and support columns using ¼" bolts and washers.
2. Fasten brackets to the slab using ¼" anchors, screws, and washers.
3. Secure netting to brackets using kayak cord.



Figure 31: Play Pod Octo Netting Installation

10.2 Safety Panels

Safety panels are made of a clear acrylic material and are an optional substitute (additional cost) to safety netting. Do not overtighten hardware to avoid cracking panels.

10.2.1 Play Pod Hex

1. Fasten panels to deck using $\frac{1}{4}$ " bolts and washers.
2. Secure panels to one another using panel connector brackets with $\frac{1}{4}$ " bolts and washers.
3. Fasten brackets to the slab using $\frac{1}{4}$ " anchors, screws, and washers.
4. Secure panels to brackets at grade using $\frac{1}{4}$ " bolts and washers.

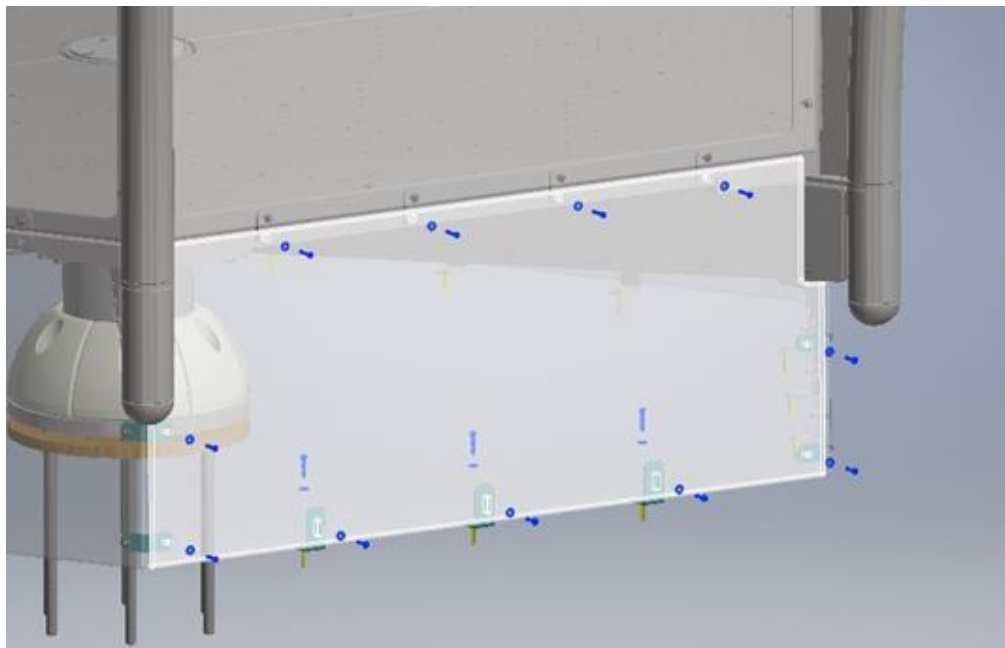

Figure 32: Play Pod Hex Panel Installation

10.2.2 Play Pod Octo

1. Fasten panels to deck using ¼" bolts and washers.
2. Secure panels to support columns using ¼" bolts and washers.

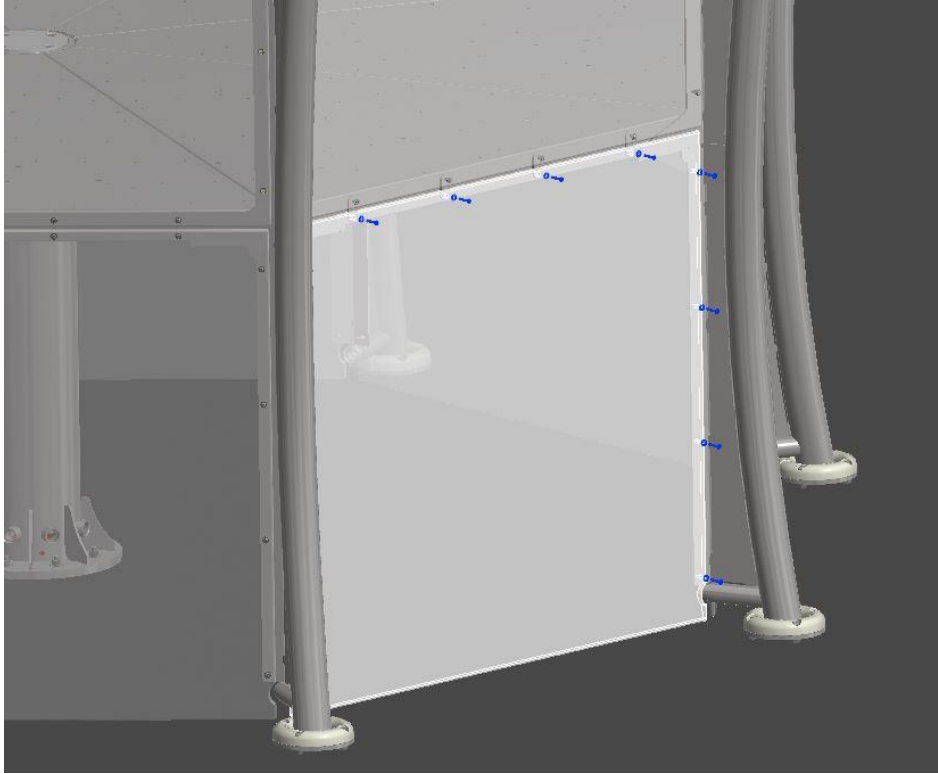

Figure 33: Play Pod Octo Panel Installation